



CHARNIÈRES INVISIBLES BROCHE RÉTRACTABLE

62-1-9000

Charnière invisible à démontage rapide et axe imperdable.

A	126 mm
Matière	inox 304

Poids (g)	95 g
B	17.5 mm
E (Charnon ou épaisseur)	3 mm
Finition	brut

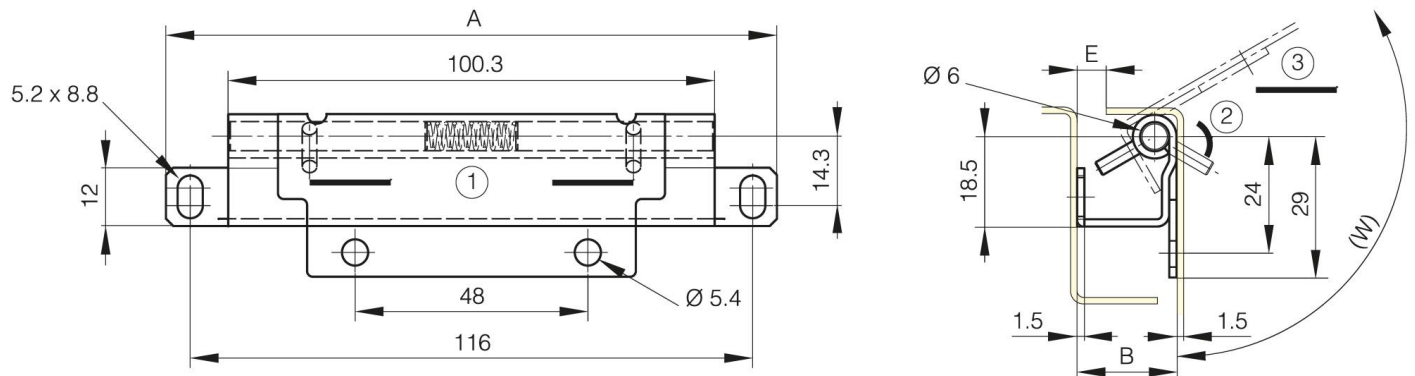

W (angle rotation)	122° Degré
---------------------------	------------