



COMPAS ACIER ZINGUÉ NOIR TYPE A

24-1-3312

A	80 mm
Matière	acier
Poids (g)	34 g

Finition

zingué noir

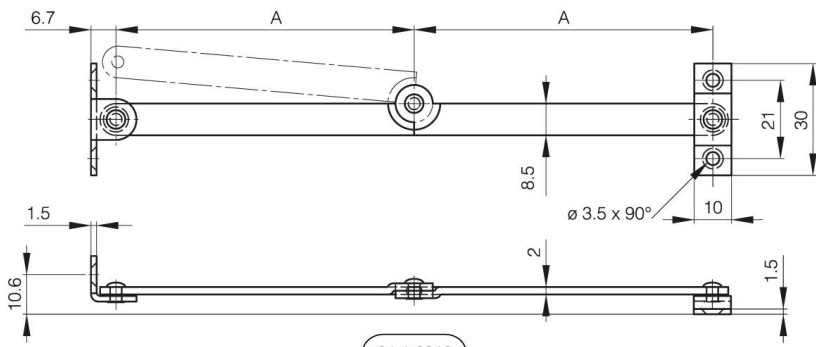

24-1-3312

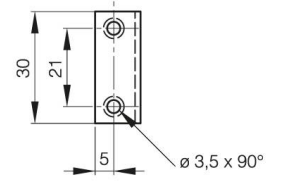

24-1-3311