



PAUMELLES ALUMINIUM 80 X 80 MM

14-7-3624

Broche acier zingué.
Fourreau nylon.

A	80 mm
Note	type 1
Matière	aluminium

Poids (g)	85 g
B	80 mm
C	3.5 mm
S (diamètre trou)	5.5 mm
D (diamètre broche ou fil)	8
Finition	anodisation argent

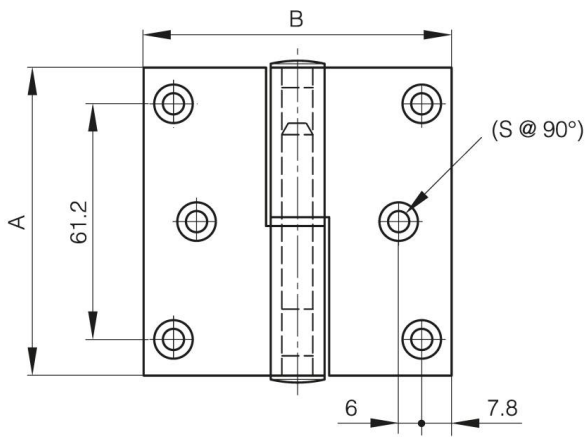

14-7-3624

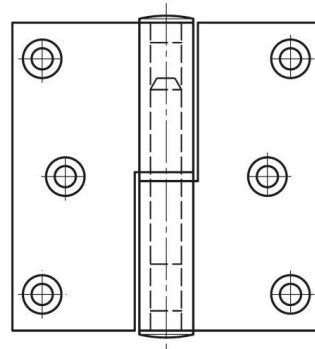

14-7-3625

