



POLYMER BUSHING LIFT-OFF HINGE

14-7-3902

Hinge tested to EN1935: 2002 grades 13-14.

Recommended for door weights less than 160 kg, annual usage up to 200,000 cycles.

Door thickness: 44 mm to 54 mm.

Standard hinge version 52-7-4132.

A	101.6 mm
Note	Type 2

Material	304 stainless steel
Weight (g)	255 g
B	88.9 mm
C	3 mm
S (hole diameter)	8.5 mm
D (pin diameter)	7
Finish	satin polished
Nouvelle référence	NEW

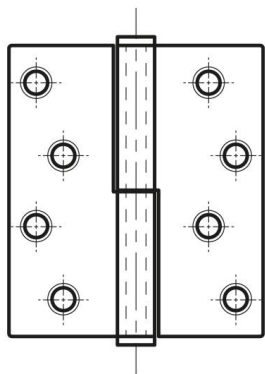

52-7-3902

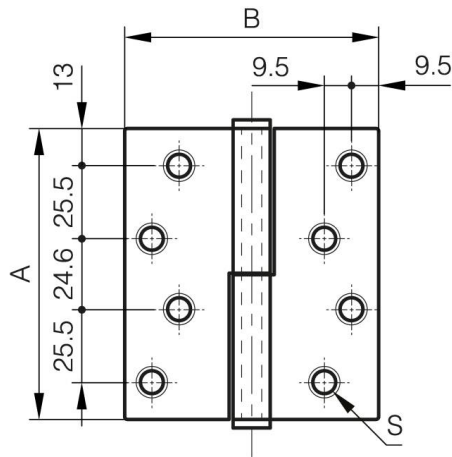

52-7-3903

