



**SPRING HINGES - ALUMINIUM PROFILE  
0.70 N.M - DIAMETER 13**

72-1-4325

Opening spring force:

M(0°): 0.7 N.m / M(90°): 0.45 N.m / M(180°): 0.23 N.m

Closing spring force:

M(0°): 0.23 N.m / M(90°): 0.45 N.m / M(180°): 0.7 N.m

3 other versions available: free swinging, with friction or with detent mechanism.

<b>A</b>	67 mm
<b>Note</b>	opening spring / delivered flat / with M6 studs
<b>Material</b>	6060 T5 alu
<b>Weight (g)</b>	85 g
<b>B</b>	55 mm
<b>C</b>	4.5 mm
<b>D (pin diameter)</b>	13
<b>Finish</b>	clear anodised
<b>Nouvelle référence</b>	NEW

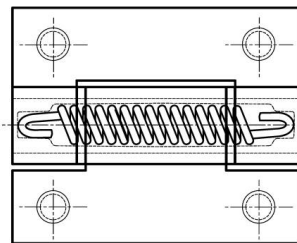
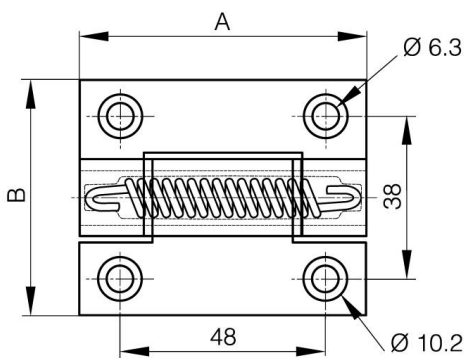

72-1-4322 & 72-1-4325  
72-1-4326 & 72-1-4335

