



**SPRING HINGES - ALUMINIUM PROFILE
0.70 N.M - DIAMETER 13**

72-1-4376

Opening spring force:

M(0°): 0.7 N.m / M(90°): 0.45 N.m / M(180°): 0.23 N.m

Closing spring force:

M(0°): 0.23 N.m / M(90°): 0.45 N.m / M(180°): 0.7 N.m

3 other versions available: free swinging, with friction or with detent mechanism.

A	67 mm
Note	opening spring/ delivered flat
Material	6060 T5 alu
Weight (g)	66 g
B	55 mm
C	4.5 mm
D (pin diameter)	13
Finish	bronze anodised
Nouvelle référence	NS

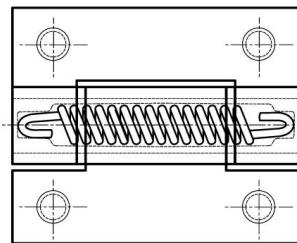
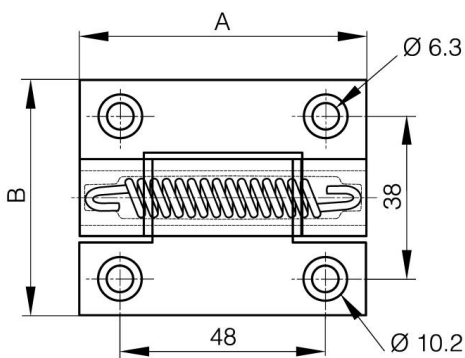

72-1-4322 & 72-1-4325
72-1-4326 & 72-1-4335

