



BLACK ZINC PLATED STAYS B

24-1-3323

A	80 mm
Material	steel
Weight (g)	33 g

Finish

black zinc plated

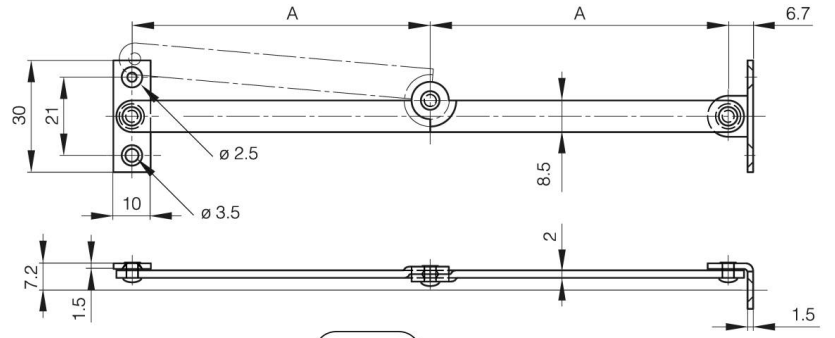
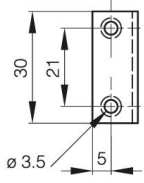

24-1-3324



24-1-3323