



BLACK ZINC PLATED STAYS A

24-1-3311

A	80 mm
Material	steel
Weight (g)	34 g

Finish

black zinc plated

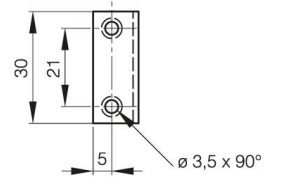
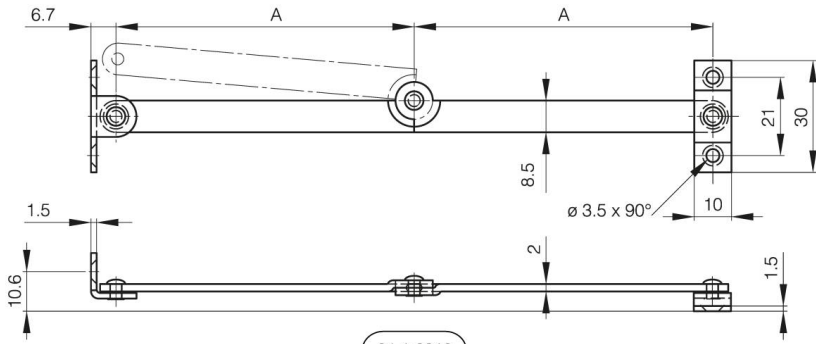

24-1-3312

24-1-3311