

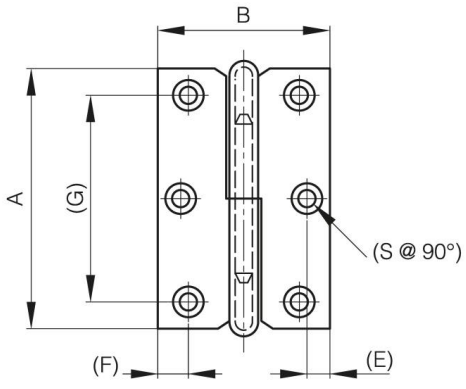

LIFT-OFF HINGES 60 TO 80 MM LONG

14-7-3401

A (length)	80 mm
Note	type 2
Material	steel
Weight (g)	59 g
B (width)	50 mm
C	1.5 mm
S	4 mm
E	7.2 mm
D (pin diameter)	5
F (pitch)	9.2 mm
G (pitch)	62 mm
Finish	nickel plated



14-7-3396 & 14-7-3398 & 14-7-3400

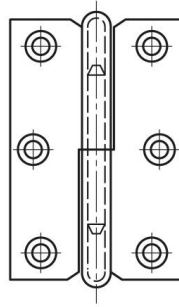

14-7-3397 & 14-7-3399 & 14-7-3401

