



LIFT-OFF HINGES 80 X 80 MM - STAINLESS STEEL WITH 6 HOLES

14-7-3730

Only the visible side has a brushed finish.

Produced mainly in stainless steel, for a complete description of the materials contact us.

A (length)	80 mm
Note	type 2 / round corners
Material	304 stainless steel
Weight (g)	175 g
B (width)	80 mm
C	2.5 mm
S	5.8 mm
D (pin diameter)	7
Finish	brushed

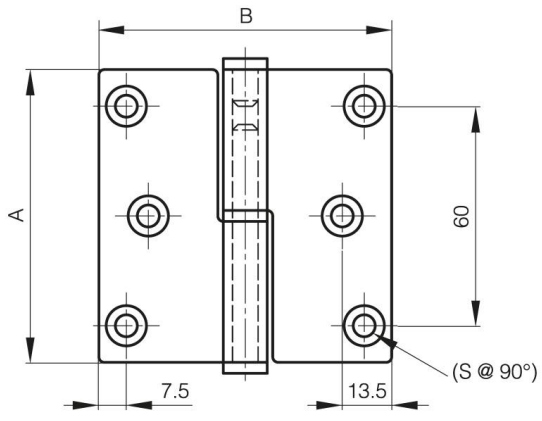

14-7-3727

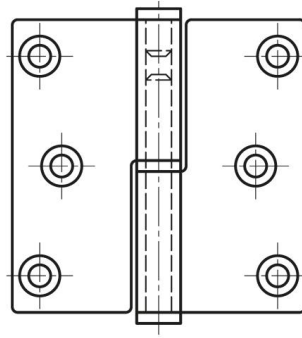

14-7-3728

