



## **FLAG HINGE WITHOUT WASHER - FLAT KNUCKLE**

**12-1-3307**

<b>A</b>	60 mm
<b>Note</b>	type 2
<b>Material</b>	steel

<b>Weight (g)</b>	39 g
<b>B</b>	40 mm
<b>C</b>	1.5 mm
<b>E (knuckle or thickness)</b>	30 mm
<b>D (pin diameter)</b>	5.3
<b>Finish</b>	raw

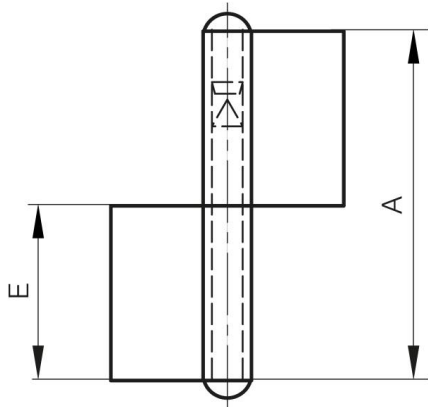

12-1-3308 & 12-1-3310

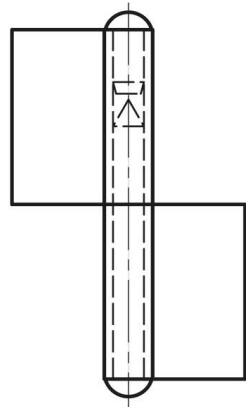

12-1-3307 & 12-1-3309

