



ALUMINIUM LIFT-OFF HINGES 80 X 80 MM

14-7-3624

Zinc plated steel pin.

Nylon bushing.

A (length)	80 mm
Note	type 1
Material	aluminium
Weight (g)	85 g
B (width)	80 mm
C	3.5 mm
S	5.5 mm
D (pin diameter)	8
Finish	anodised silver

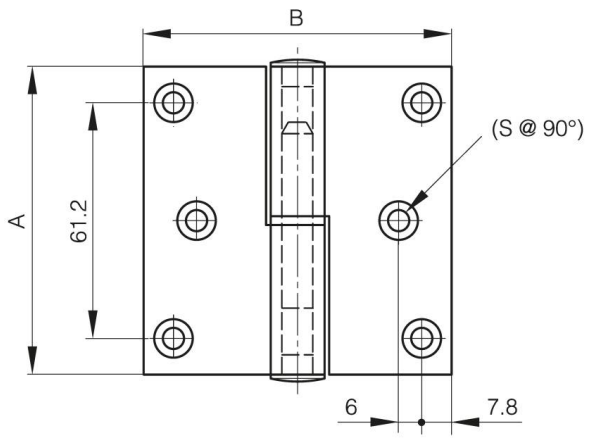

14-7-3624

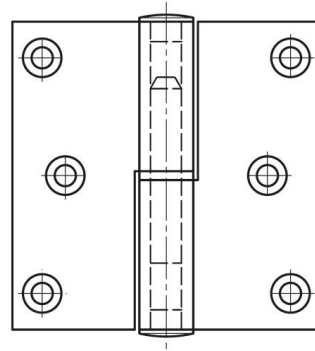

14-7-3625

