



KLAPPENAUFSTELLER VERZINKT SCHWARZ STAHL B

24-1-3324

A	80 mm
Material	Stahl
Gewicht (g)	33 g

Dekor

schwarz verzinkt

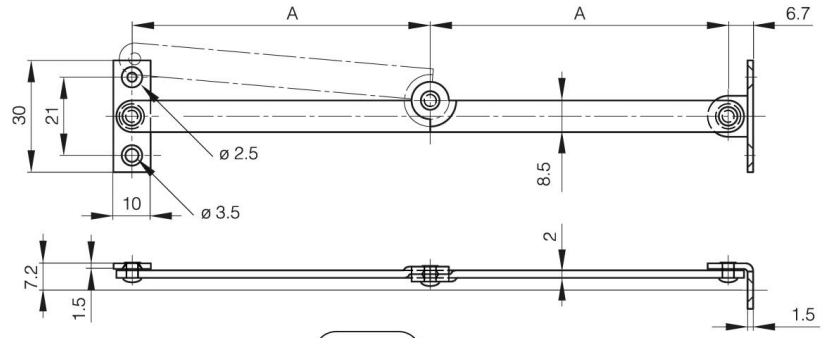
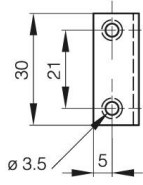

24-1-3324



24-1-3323