



KLAPPENAUFSTELLER VERZINKT SCHWARZ STAHL A

24-1-3311

A	80 mm
Material	Stahl
Gewicht (g)	34 g

Dekor

schwarz verzinkt

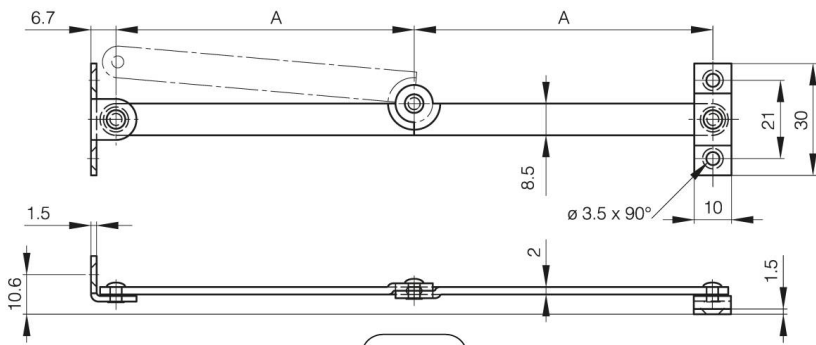

24-1-3312

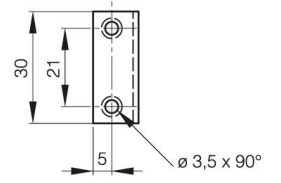

24-1-3311