



FITSCHEN MIT UNTERLEGSCHLEIBE 62 X 62 MM

12-1-3634

Fitschen mit Messingunterlegscheibe.

A	62 mm
Ausführung	Typ 2

Material	Stahl
Gewicht (g)	87 g
B	62 mm
C	2.5 mm
E (Gelenkteile oder Dicke)	30 mm
D (Durchmesser)	7
Dekor	unbehandelt

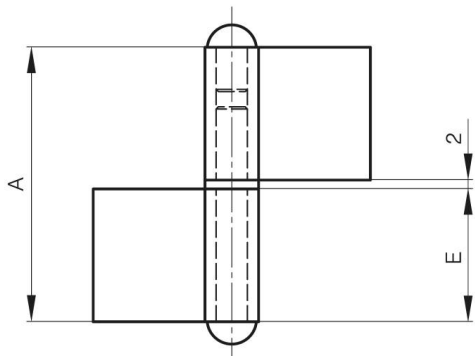

12-1-3635

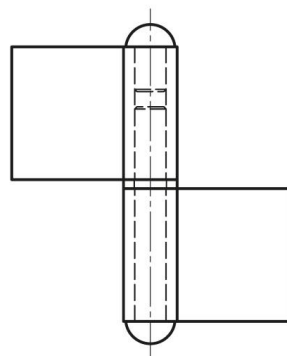

12-1-3634

